



PART NUMBERING

W	Without Certification (Industrial)	
DCG	Name Of Gland	
B	Brass	
N	Nickel Plating	
Sa	AISI303 Stainless Steel	
Sb	AISI304 Stainless Steel	
Sc	AISI316L Stainless Steel	
A	Aluminium	
1	TPV Seal (-30 / +100 °c)	1a
	PA6 V0 Washer (-40 / +100 °c)	
	PA6 V0 Upper Washer (-40 / +100 °c)	
2	Nbr Seal (-30 / +100 °c)	2a
	PA6 V0 Washer (-40 / +100 °c)	
	PA6 V0 Upper Washer (-40 / +100 °c)	
3	Neoprene Seal (-40 / +100 °c)	3a 3a2
	PA6 V0 Washer (-40 / +100 °c)	
	PA6 V0 Upper Washer (-40 / +100 °c)	
4	Silicone Seal (-60 / +180 °c)	4a
	Silicone Washer (-60 / +180 °c)	
	Teflon Upper Silicone (-200 / +260 °c)	
*	Cable Dia.	
**	Thread Type	
K	Kit (Earth Tag + Pvc Shroud)	
E	Earth Tag	
T	Tpv Shroud (halogen Free)	
P	Pvc Shroud	

Alternative Washer Options	
1a	Nbr Washer (-30 / +100 °c)
2a	Nbr Washer (-30 / +100 °c)
3a	Nbr Washer (-30 / +100 °c)
3a2	Neoprene Washer (-40 / +100 °c)
3b	Teflon Upper Washer (-200 / +260 °c)
4a	Teflon Upper Washer (-200 / +260 °c)

W	DCG	B	1	*	**	K	t
		N	2			E	p
		Sa	3				
		Sb	4				
		Sc					
		A					

WDCGN1-20-M20-t
DCGN1-20-M20-t

DCGSc2-20-M20-K
DCGSc2-20-M20-Kt

W D C G X X - X - X - X - X

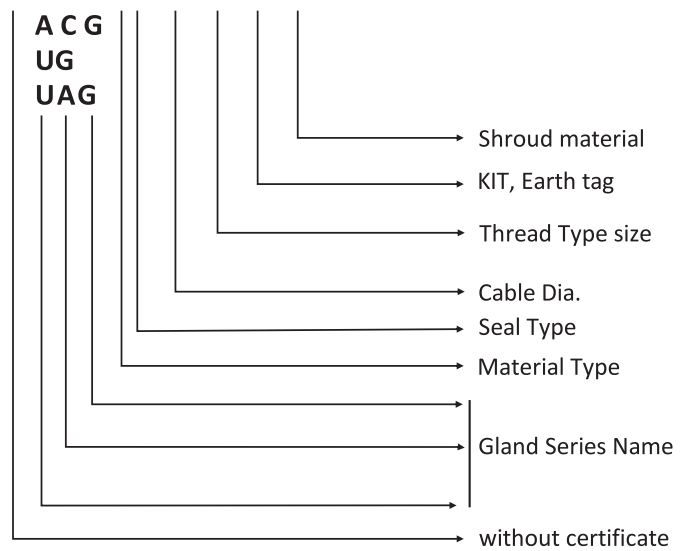

Example Parts Numbering

DCGN1-32-M32	M32x1,5 Etna Serie Double Compression Brass Nickel Plated Ex Cable Glands
DCGN1-32-M32-K	M32x1,5 Etna Serie Double Compression Brass Nickel Plated Ex Cable Gland Kit
ACGSa2-32-M32	M32x1,5 Colima Serie Single Compression 303 Stainless Steel Ex Cable Glands
ACGSa2-32-M32-E	M32x1,5 Colima Serie Single Compression 303 Stainless Steel Ex Cable Glands + Earth Tag
DCGSc3-32-N1/2	NPT 1/2 Etna Serie Double Compression 316L Stainless Steel Ex Cable Glands + Shroud
DCGSc3-32-G1/2-t	GAS 1/2 Etna Serie Double Compression 316L Stainless Steel Ex Cable Glands + TPV Shroud
ACGS3-32-P11s-Kt	PG11s Colima Serie Single Compression 316L Stainless Steel Ex Cable Glands + Kit (with TPV Shroud)

DCG DOUBLE COMPRESSION

TECHNICAL DETAILS

Type	: DCG (Double compression gland)
Protection code	: II 2G Exd/e IIC Gb II 1D Ex ta IIIC Da I M2 Exd/e I Mb
Certificate	: IEP 14 ATEX 0216U
Material	: MS58 Brass with or without nickel plated Stainless steel AISI303 / 316L / Aluminium
Standards	: EN 60079-0:2009, 60079-1:2007, 60079-31:2009
Protection class	: EN60529 IP66 / 68
Temperature	: -30 °C / +120 °C NBR -40 °C / +100 °C NEOPRENE -60 °C / +180 °C SILICONE -30 °C / +100 °C TPE/V
Application area	: ZONE1, ZONE2, ZONE21, ZONE22, Gas Groups IIA, IIB, IIC
Cable type	: SWA (Single wire armour) (STA & other cables optional)

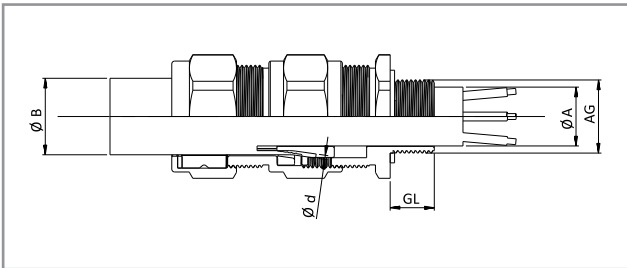
**ARMoured
CABLE GLANDS
DCG SERIES**

PRODUCT RANGE OVERVIEW

Product Size	Product Code	Standard AG	AG NPT	AG	A		B		Ø d (Armour)		GL mm	mm
					Min	Max	Min	Max	Min	Max		
16	DCGXX/16/X	M16x1,5	1/2"	PG9	3,1	8,6	6,1	13,2	0,8	1,0	15	24
20ss	DCGXX/20ss/X	M20ssx1,5	1/2"	PG11ss	3,1	8,6	6,1	13,2	0,8	1,0	15	24
20s	DCGXX/20s/X	M20sx1,5	1/2"	PG11s	6,1	11,6	9,5	15,9	0,8	1,25	15	24
20	DCGXX/20/X	M20x1,5	1/2"	PG13,5	6,5	13,9	12,5	20,9	0,8	1,25	15	30
25s	DCGXX/25s/X	M25sx1,5	3/4"	PG21s	11,1	19,9	14	22	1,25	1,60	15	38
25	DCGXX/25/X	M25x1,5	3/4"	PG21	11,1	19,9	18,2	26,2	1,25	1,60	15	38
32	DCGXX/32/X	M32x1,5	1"	PG29	18,2	26,2	23,7	33,9	1,6	2,0	15	45
40	DCGXX/40/X	M40x1,5	1 1/4"	PG36s	23,7	33,9	27,9	40,4	1,6	2,0	15	55
50s	DCGXX/50s/X	M50sx1,5	1 1/2"	PG36	29,5	38,1	35,2	46,7	2,0	2,5	15	60
50	DCGXX/50/X	M50x1,5	2"	PG42	35,6	44,0	40,4	53,1	2,0	2,5	15	70
63s	DCGXX/63s/X	M63sx1,5	2"	PG48	40,1	49,9	45,6	59,4	2,0	2,5	15	75
63	DCGXX/63/X	M63x1,5	2 1/2"	-	47,2	55,9	54,6	65,9	2,0	2,5	15	80
75s	DCGXX/75s/X	M75sx1,5	2 1/2"	-	52,8	61,9	59	72,1	2,0	2,5	15	90
75	DCGXX/75/X	M75x1,5	3"	-	59,1	67,9	66,7	78,5	2,5	3,0	15	100
90	DCGXX/90/X	M90x2,0	3"	-	66,6	79,9	76,2	90,4	3,0	3,5	15	115
100	DCGXX/100/X	M100x2,0	-	-	76	90	86,1	101,5	3,15	4,0	15	123
115	DCGXX/115/X	M115x2,0	-	-	86	97,9	101,5	110,3	3,15	4,0	15	133
130	DCGXX/130/X	M130x2,0	-	-	97	114,9	114,2	123,3	3,15	4,0	15	146

ORTAC Ex COLIMASERIES



ACG SINGLE COMPRESSION



TECHNICAL DETAILS

Type	: ACG (Armoured cable gland)
Protection code	: II 2G Exd/e IIC Gb II 1D Ex ta IIIC Da I M2 Exd/e I Mb
Certificate	: IEP 14 ATEX 0215 U
Material	: MS58 Brass with or without nickel plated Stainless steel AISI303 / 316L / Aluminium
Standards	: EN 60079-0:2009, 60079-1:2007, 60079-31:2009
Protection class	: EN60529 IP66 / 68
Temperature	: -30 °C / +120 °C NBR -40 °C / +100 °C NEOPRENE -60 °C / +180 °C SILICONE -30 °C / +100 °C TPE/V
Application area	: ZONE1, ZONE2, ZONE21, ZONE22, Gas Groups IIA, IIB, IIC
Cable type	: SWA (Single wire armour) (STA & other cables optional)

ARMOURED CABLE GLANDS ACG SERIES

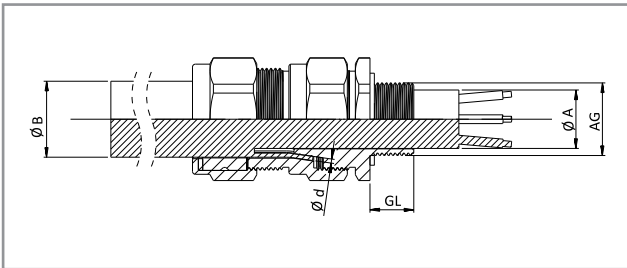

PRODUCT RANGE OVERVIEW

Product Size	Product Code	Standard AG	AG NPT	AG	A Min	B		Ø d (Armour)		GL mm	mm
						Min	Max	Min	Max		
16	ACGXX/16/X	M16x1,5	1/2"	PG9	8,6	6,1	13,2	0,8	1,0	15	24
20ss	ACGXX/20ss/X	M20ssx1,5	1/2"	PG11ss	8,6	6,1	13,2	0,8	1,0	15	24
20s	ACGXX/20s/X	M20sx1,5	1/2"	PG11s	11,6	9,5	15,9	0,8	1,25	15	24
20	ACGXX/20/X	M20x1,5	1/2"	PG13,5	13,9	12,5	20,9	0,8	1,25	15	30
25s	ACGXX/25s/X	M25sx1,5	3/4"	PG21s	19,9	14	22	1,25	1,60	15	38
25	ACGXX/25/X	M25x1,5	3/4"	PG21	19,9	18,2	26,2	1,25	1,60	15	38
32	ACGXX/32/X	M32x1,5	1"	PG29	26,2	23,7	33,9	1,6	2,0	15	45
40	ACGXX/40/X	M40x1,5	1 1/4"	PG36s	33,9	27,9	40,4	1,6	2,0	15	55
50s	ACGXX/50s/X	M50sx1,5	1 1/2"	PG36	38,1	35,2	46,7	2,0	2,5	15	60
50	ACGXX/50/X	M50x1,5	2"	PG42	44,0	40,4	53,1	2,0	2,5	15	70
63s	ACGXX/63s/X	M63sx1,5	2"	PG48	49,9	45,6	59,4	2,0	2,5	15	75
63	ACGXX/63/X	M63x1,5	2 1/2"	-	55,9	54,6	65,9	2,0	2,5	15	80
75s	ACGXX/75s/X	M75sx1,5	2 1/2"	-	61,9	59	72,1	2,0	2,5	15	90
75	ACGXX/75/X	M75x1,5	3"	-	67,9	66,7	78,5	2,5	3,0	15	100
90	ACGXX/90/X	M90x2,0	3"	-	79,9	76,2	90,4	3,0	3,5	15	115
100	ACGXX/100/X	M100x2,0	-	-	90	86,1	101,5	3,15	4,0	15	123
115	ACGXX/115/X	M115x2,0	-	-	97,9	101,5	110,3	3,15	4,0	15	133
130	ACGXX/130/X	M130x2,0	-	-	114,9	114,2	123,3	3,15	4,0	15	146

ORTAC Ex MERAPI SERIES



UAG UNARMOURED CABLE GLANDS



TECHNICAL DETAILS

- Type : UAG (Un-Ar) Armoured gland)
- Protection code : II 2G Exd/e IIC Gb II 1D Ex ta IIIC Da I M2 Exd/e I Mb
- Certificate : IEP 14 ATEX 0217 U
- Material : MS58 Brass with or without nickel plated
Stainless steel AISI303 / 316L / Aluminium
- Standards : EN 60079-0:2009, 60079-1:2007,60079-31:2009
- Protection class : EN60529 IP66 / 68
- Temperature : -30 °C / +120 °C NBR
-40 °C / +100 °C NEOPRENE
-60 °C / +180 °C SILICONE
-30 °C / +100 °C TPE/V
- Application area : ZONE1, ZONE2, ZONE21, ZONE22,
Gas Groups IIA, IIB, IIC
- Cable type : Unarmoured

UNARMOURED CABLE GLANDS UAG SERIES

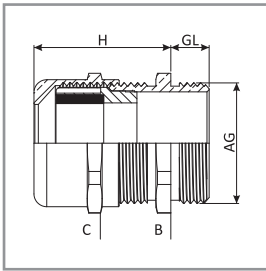

PRODUCT RANGE OVERVIEW

Product Size	Product Code	Standard AG	AG	GL min. mm	Clamping Range mm	B mm	C
Exd							
12	UAGXX/12/X	M12x1,5	3/8"	15	3-6,5	14	14
16	UAGXX/16/X	M16x1,5	3/8"	15	4-8	18	17
20	UAGXX/20/X	M20x1,5	1/2"	15	6-12	22	22
25s	UAGXX/25s/X	M25x1,5	3/4"	15	10-14	27	24
25	UAGXX/25/X	M25x1,5	3/4"	15	13-18	30	30
32	UAGXX/32/X	M32x1,5	1"	15	13-18	34	30
40	UAGXX/40/X	M40x1,5	1 1/4"	15	18-25	43	40
50	UAGXX/50/X	M50x1,5	1 1/2"	15	22-32	55	50
63s	UAGXX/63s/X	M63x1,5	2"	15	33-44	68	64
63	UAGXX/63/X	M63x1,5	2"	15	45-55	70	75
75s	UAGXX/75s/X	M75x1,5	2 1/2"	15	45-55	85	75
75	UAGXX/75/X	M75x1,5	2 1/2"	20	50-63	90	90
80	UAGXX/80/X	M80x2,0	3"	20	50-63	90	90
90	UAGXX/90/X	M90x2,0	3"	20	60-70	100	100
Exe							
12	EUAGXX/12/X	M12x1,5	3/8"	6	3-6,5	14	14
16	EUAGXX/16/X	M16x1,5	3/8"	7	4-8	18	17
20	EUAGXX/20/X	M20x1,5	1/2"	8	6-12	22	22
25s	EUAGXX/25s/X	M25x1,5	3/4"	8	10-14	27	24
25	EUAGXX/25/X	M25x1,5	3/4"	8	13-18	30	30
32	EUAGXX/32/X	M32x1,5	1"	9	13-18	34	30
40	EUAGXX/40/X	M40x1,5	1 1/4"	9	18-25	43	40
50	EUAGXX/50/X	M50x1,5	1 1/2"	9	22-32	55	50
63s	EUAGXX/63s/X	M63x1,5	2"	14	33-44	68	64
63	EUAGXX/63/X	M63x1,5	2"	15	45-55	70	75
75s	EUAGXX/75s/X	M75x1,5	2 1/2"	15	45-55	85	75
75	EUAGXX/75/X	M75x1,5	2 1/2"	20	50-63	90	90
80	EUAGXX/80/X	M80x2,0	3"	20	50-63	90	90
90	EUAGXX/90/X	M90x2,0	3"	20	60-70	100	100

UG UNARMOURED CABLE GLANDS



TECHNICAL DETAILS

Type : UG (Un-Ar) Armoured gland
 Protection code : II 2G Exd/e IIC Gb II 1D Ex ta IIIC Da I M2 Exd/e I Mb
 Certificate : IEP 14 ATEX 0217 U
 Material : MS58 Brass with or without nickel plated
 Stainless steel AISI303 / 316L / Aluminium
 Standards : EN 60079-0:2009, 60079-1:2007, 60079-31:2009
 Protection class : EN60529 IP66 / 68
 Temperature : -30 °C / +120 °C NBR
 -40 °C / +100 °C NEOPRENE
 -60 °C / +180 °C SILICONE
 -30 °C / +100 °C TPE/V
 Application area : ZONE1, ZONE2, ZONE21, ZONE22,
 Gas Groups IIA, IIB, IIC
 Cable type : Unarmoured

UNARMOURED
CABLE GLANDS
UG SERIES

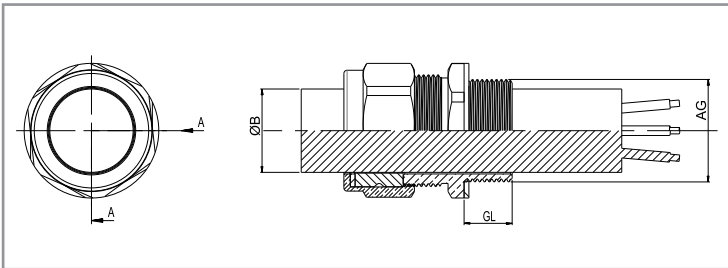

PRODUCT RANGE OVERVIEW

Product Size	Product Code	Standard AG	AG NPT	B		GL min. mm	C	
				Min	Max		mm	B
16	UGXX/16/X	M16x1,5	1/2"	6,1	11,6	15	20	24
20s	UGXX/20s/X	M20sx1,5	1/2"	6,1	13,2	15	24	24
20	UGXX/20/X	M20x1,5	1/2"	9,5	15,9	15	24	24
25	UGXX/25/X	M25x1,5	3/4"	12,5	20,5	15	30	30
32	UGXX/32/X	M32x1,5	1"	18,2	26,2	15	38	38
40	UGXX/40/X	M40x1,5	1 1/4"	23,7	33,9	15	45	45
50	UGXX/50/X	M50x1,5	1 1/2"	27,9	40,4	15	55	55
63s	UGXX/63s/X	M63sx1,5	2"	40,4	51	15	70	70
63	UGXX/63/X	M63x1,5	2 1/2"	47,2	55,9	15	70	80
75s	UGXX/75s/X	M75sx1,5	2 1/2"	52,8	59	15	80	80
75	UGXX/75/X	M75x1,5	3"	59,1	67,9	15	90	100

ORTAC **Ex**

AG ARMoured CABLE GLANDS

TECHNICAL DETAILS

Certificate	: GOST-R
Standards	: EN 60079-0 / EN 60079-1 / EN 60079-31
Protection class	: IP 55
Materials	: MS58 / Stainless steel
Thread norm	: EN 60423 / DIN 40430 / ASME B 1.20.1 / DIN 259

ARMoured CABLE GLANDS AG SERIES

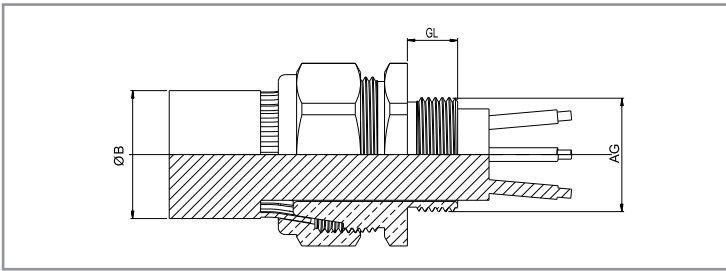
PRODUCT RANGE OVERVIEW

Product Size	Product Code	Standard AG	AG NPT	B		GL	C	
				Min	Max		mm	B
16	AGXX/16/X	M16x1,5	3/8"	7	11	10	27	22
20s	AGXX/20s/X	M20sx1,5	1/2"	11	16	10	29	24
20	AGXX/20/X	M20x1,5	1/2"	13	21	11	33	30
25	AGXX/25/X	M25x1,5	3/4"	19	27	11	40	36
32	AGXX/32/X	M32x1,5	1"	26	34	14	47	42
40	AGXX/40/X	M40x1,5	1 1/4"	32	40	14	56	50
50s	AGXX/50s/X	M50sx1,5	1 1/2"	38	45	15	61	55
50	AGXX/50/X	M50x1,5	2"	43	52	15	67	60
63s	AGXX/63s/X	M63sx1,5	2"	50	62	15	79	70
63	AGXX/63/X	M63x1,5	2 1/2"	56	68	15	89	80
75s	AGXX/75s/X	M75sx1,5	2 1/2"	62	72	15	95	95
75	AGXX/75/X	M75x1,5	3"	68	78	15	100	100



PART NUMBERING

AP-RC-CP TK-TO-TS-NP	Accessories Code
B	Brass
N	Nickel Plating
Sa	AISI303 Stainless Steel
Sb	AISI304 Stainless Steel
Sc	AISI316 Stainless Steel
A	Aluminium
1	NBR O-ring (-30°C +100 °C)
2	Silicone O-ring (-60°C +180 °C)

Accessories Descriptions
"AP" Adapter
"RC" Reducer
"TK" TK Series Stopper Plugs
"TO" TO Series Stopper Plugs
"TS" TS Series Stopper Plugs
"CP" Coupling
"NP" Nipple

m	Male
f	Female
*	Application Size
**	Cable Gland Connection Size

APB1/M20fN14m RCB2/N12mPG11f

AP	B	1	*	m/f	**	m/f
RC	N	2				
TK	Sa					
TO	Sb					
TS	Sc					
CP	A					
NP						

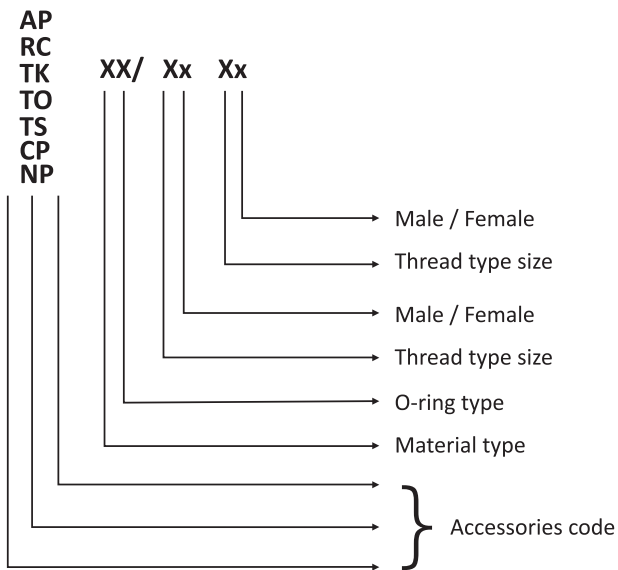

Example Part Numbering

APB1/M20fN14m	M20 female NPT 1/4" male brass adapter with NBR o-ring
RCB2/N12mPG11f	NPT 1/2" male PG11 female brass reducer with silicone o-ring
TKN1/M16	M16 TK series brass nickel plated stopper plug with NBR o-ring
TOB1/N12	NPT 1/2" TO series brass stopper plug with NBR o-ring
TSB2/M25	M25 TS series brass stopper plug with silicone o-ring

STOPPER PLUG

TECHNICAL DETAILS

Type	: TK-XX / STOPPER PLUG
Protection code	: II 2G Exd/e IIC Gb II 1D Ex ta IIIC Da I M2 Ex d/e I Mb
Certificate	: IEP 15 ATEX 0333U
Material	: Brass, brass with nickel plated, stainless steel
Standards	: EN 60079-0 2009 /60079-1 2007/ 60079-31 2009
O-ring	: NBR / Silicone
Temperature range	: -60 °C +200 °C
Protection class	: IP66-IP68 (EN 60529)
Application area	: ZONE1 , ZONE 2, ZONE 21 , ZONE 22 Gas groups IIA , IIB , IIC

STOPPER PLUG

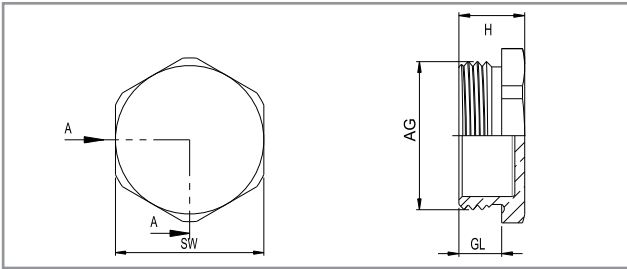
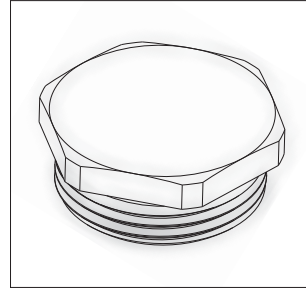
PRODUCT RANGE OVERVIEW

Product Size	Product Code	GL min. mm	H mm	SW mm
M12 x 1,5	TK-XX/M12	15	22	17
M16 x 1,5	TK-XX/M16	15	22	22
M20 x 1,5	TK-XX/M20	15	22	24
M25 x 1,5	TK-XX/M25	15	22	30
M32 x 1,5	TK-XX/M32	15	22	36
M40 x 1,5	TK-XX/M40	15	22	45
M50 x 1,5	TK-XX/M50	15	22	55
M63 x 1,5	TK-XX/M63	15	22	70
M75 x 1,5	TK-XX/M75	15	22	80
M90 x 2	TK-XX/M90	20	27	95
M100 x 2	TK-XX/M100	20	27	110
NPT 1/4"	TK-XX/N14	15	22	15
NPT 3/8"	TK-XX/N38	15	22	20
NPT 1/2"	TK-XX/N12	15	22	24
NPT 3/4"	TK-XX/N34	15	22	27
NPT 1"	TK-XX/N100	15	22	35
NPT 1 1/4"	TK-XX/N114	15	22	45
NPT 1 1/2"	TK-XX/N112	15	22	50
NPT 2"	TK-XX/N200	15	22	65
NPT 2 1/2"	TK-XX/N212	20	27	75
NPT 3"	TK-XX/N300	20	27	90
NPT 4"	TK-XX/N400	20	27	115
G 1/4"	TK-XX/G14	15	22	18
G 3/8"	TK-XX/G38	15	22	22
G 1/2"	TK-XX/G12	15	22	25
G 3/4"	TK-XX/G34	15	22	32
G 1"	TK-XX/G100	15	22	38
G 1 1/4"	TK-XX/G114	15	22	45
G 1 1/2"	TK-XX/G112	15	22	55
G 2"	TK-XX/G200	15	22	65
G 2 1/2"	TK-XX/G212	20	27	85
G 3"	TK-XX/G300	20	27	95
G 4"	TK-XX/G400	20	27	120
PG7	TK-XX/P7	15	22	17
PG9	TK-XX/P9	15	22	20
PG 11	TK-XX/P11	15	22	25
PG 13,5	TK-XX/P13	15	22	25
PG16	TK-XX/P16	15	22	27
PG21	TK-XX/P21	15	22	35
PG29	TK-XX/P29	15	22	42
PG36	TK-XX/P36	15	22	55
PG42	TK-XX/P42	15	22	60
PG48	TK-XX/P48	15	22	65

STOPPER PLUG



TECHNICAL DETAILS

Type : TS-XX / STOPPER PLUG
 Protection code : II 2G Exd/e IIC Gb II 1D Ex ta IIIC Da
 I M2 Ex d/e I Mb
 Certificate : IEP 15 ATEX 0333U
 Material : Brass, brass with nickel plated, stainless steel
 Standards : EN 60079-0 2009 /60079-1 2007/ 60079-31 2009
 O-ring : NBR / Silicone
 Temperature range : -60 °C +200 °C
 Protection class : IP66-IP68 (EN 60529)
 Application area : ZONE1 , ZONE 2, ZONE 21 , ZONE 22
 Gas groups IIA , IIB , IIC

STOPPER PLUG

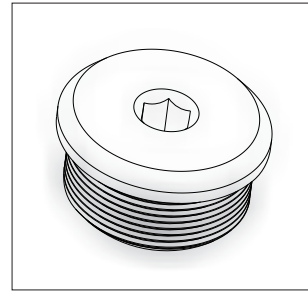
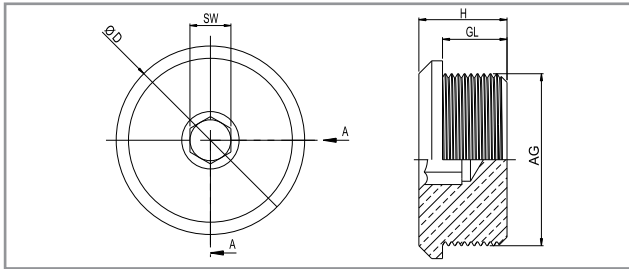

PRODUCT RANGE OVERVIEW

Product Size	Product Code	GL min. mm	H mm	D mm	SW mm
M12 x 1,5	TS-XX-M12	15	21	17	6
M16 x 1,5	TS-XX-M16	15	21	22	8
M20 x 1,5	TS-XX-M20	15	21	27	10
M25 x 1,5	TS-XX-M25	15	21	30	10
M32 x 1,5	TS-XX-M32	15	21	36	10
M40 x 1,5	TS-XX-M40	15	21	46	10
M50 x 1,5	TS-XX-M50	15	21	55	10
M63 x 1,5	TS-XX-M63	15	21	68	10
M75 x 1,5	TS-XX-M75	15	21	80	14
M90 x 2	TS-XX-M90	20	26	95	14
M100 x 2	TS-XX-M100	20	26	108	14
NPT 1/4"	TS-XX-N14	15	21	19	6
NPT 3/8"	TS-XX-N38	15	21	23	8
NPT 1/2"	TS-XX-N12	15	21	27	10
NPT 3/4"	TS-XX-N34	15	21	32	10
NPT 1"	TS-XX-N100	15	21	39	10
NPT 1 1/4"	TS-XX-N114	15	21	48	10
NPT 1 1/2"	TS-XX-N112	15	21	55	10
NPT 2"	TS-XX-N200	15	21	65	10
NPT 2 1/2"	TS-XX-N212	20	26	78	14
NPT 3"	TS-XX-N300	20	26	95	14
NPT 4"	TS-XX-N400	20	26	120	14
G 1/4"	TS-XX-G14	15	21	19	6
G 3/8"	TS-XX-G38	15	21	22	8
G 1/2"	TS-XX-G12	15	21	26	10
G 3/4"	TS-XX-G34	15	21	32	10
G 1"	TS-XX-G100	15	21	39	10
G 1 1/4"	TS-XX-G114	15	21	45	10
G 1 1/2"	TS-XX-G112	15	21	53	10
G 2"	TS-XX-G200	15	21	65	10
G 2 1/2"	TS-XX-G212	20	26	80	14
G 3"	TS-XX-G300	20	26	93	14
G 4"	TS-XX-G400	20	26	118	14
PG7	TS-XX-P7	15	21	18	6
PG9	TS-XX-P9	15	21	21	8
PG 11	TS-XX-P11	15	21	24	10
PG 13,5	TS-XX-P13	15	21	26	10
PG16	TS-XX-P16	15	21	28	10
PG21	TS-XX-P21	15	21	34	10
PG29	TS-XX-P29	15	21	42	10
PG36	TS-XX-P36	15	21	52	10
PG42	TS-XX-P42	15	21	59	10
PG48	TS-XX-P48	15	21	65	10

STOPPER PLUG



STOPPER
PLUG

TECHNICAL DETAILS

Type : TO-XX / STOPPER PLUG
 Protection code : II 2G Exd/e IIC Gb II 1D Ex ta IIIC Da
 I M2 Ex d/e I Mb
 Certificate : IEP 15 ATEX 0333U
 Material : Brass, brass with nickel plated, stainless steel
 Standards : EN 60079-0 2009 /60079-1 2007/ 60079-31 2009
 O-ring : NBR / Silicone
 Temperature range : -60 °C +200 °C
 Protection class : IP66-IP68 (EN 60529)
 Application area : ZONE1 , ZONE 2 , ZONE 21 , ZONE 22
 Gas groups IIA , IIB , IIC

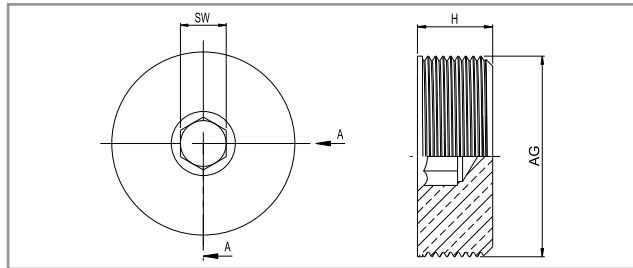

PRODUCT RANGE OVERVIEW

Product Size	Product Code	GL min. mm	SW mm
M12 x 1.5	TO-XX/M12	15	6
M16 x 1.5	TO-XX/M16	15	8
M20 x 1.5	TO-XX/M20	15	10
M25 x 1.5	TO-XX/M25	15	10
M32 x 1.5	TO-XX/M32	15	10
M40 x 1.5	TO-XX/M40	15	10
M50 x 1.5	TO-XX/M50	15	10
M63 x 1.5	TO-XX/M63	15	10
M75 x 1.5	TO-XX/M75	15	14
M90 x 2	TO-XX/M90	20	14
M100 x 2	TO-XX/M100	20	14
NPT 1/4"	TO-XX/N14	15	6
NPT 3/8"	TO-XX/N38	15	8
NPT 1/2"	TO-XX/N12	15	10
NPT 3/4"	TO-XX/N34	15	10
NPT 1"	TO-XX/N100	15	10
NPT 1 1/4"	TO-XX/N114	15	10
NPT 1 1/2"	TO-XX/N112	15	10
NPT 2"	TO-XX/N200	15	10
NPT 2 1/2"	TO-XX/N212	20	14
NPT 3"	TO-XX/N300	20	14
NPT 4"	TO-XX/N400	20	14
G 1/4"	TO-XX/G14	15	6
G 3/8"	TO-XX/G38	15	8
G 1/2"	TO-XX/G12	15	10
G 3/4"	TO-XX/G34	15	10
G 1"	TO-XX/G100	15	10
G 1 1/4"	TO-XX/G114	15	10
G 1 1/2"	TO-XX/G112	15	10
G 2"	TO-XX/G200	15	10
G 2 1/2"	TO-XX/G212	20	14
G 3"	TO-XX/G300	20	14
G 4"	TO-XX/G400	20	14
PG7	TO-XX/P7	15	6
PG9	TO-XX/P9	15	8
PG 11	TO-XX/P11	15	10
PG 13,5	TO-XX/P13	15	10
PG16	TO-XX/P16	15	10
PG21	TO-XX/P21	15	10
PG29	TO-XX/P29	15	10
PG36	TO-XX/P36	15	10
PG42	TO-XX/P42	15	10
PG48	TO-XX/P48	15	10

ADAPTER



TECHNICAL DETAILS

Type : AP-XX / ADAPTER
 Protection code : II 2G Exd/e IIC Gb II 1D Ex ta IIIC Da
 I M2 Ex d/e I Mb
 Certificate : IEP 15 ATEX 0333U
 Material : Brass, brass with nickel plated, stainless steel
 Standards : EN 60079-0 2009 /60079-1 2007/ 60079-31 2009
 O-ring : NBR / Silicone
 Temperature range: -60 °C +200 °C
 Protection class : IP66-IP68 (EN 60529)
 Application area : ZONE1 , ZONE 2, ZONE 21 , ZONE 22
 Gas groups IIA , IIB , IIC

ADAPTER

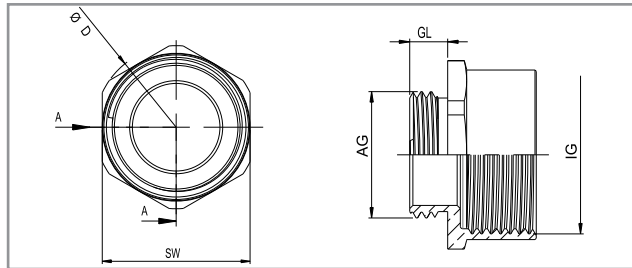

PRODUCT RANGE OVERVIEW

Product Size	Product Code	IG (F)	GL min. mm	H mm	SW mm
M12 x 1,5	APXX/M12m-N14f	NPT 1/4"	15	33,5	18
M12 x 1,5	APXX/M12m-N38f	NPT 3/8"	15	33,5	20
M16 x 1,5	APXX/M16m-N38f	NPT 3/8"	15	33,5	20
M16 x 1,5	APXX/M16m-N12f	NPT 1/2"	15	34	25
M20 x 1,5	APXX/M20m-N12f	NPT 1/2"	15	34	25
M20 x 1,5	APXX/M20m-N34f	NPT 3/4"	15	34	30
M25 x 1,5	APXX/M25m-N34f	NPT 3/4"	15	34	30
M25 x 1,5	APXX/M25m-N100f	NPT 1"	15	34	36
M32 x 1,5	APXX/M32m-N100f	NPT 1"	15	34	36
M32 x 1,5	APXX/M32m-N114f	NPT 1 1/4"	15	37	45
M40 x 1,5	APXX/M40m-N114f	NPT 1 1/4"	18	40	45
M40 x 1,5	APXX/M40m-N112f	NPT 1 1/2"	18	40	55
M50 x 1,5	APXX/M50m-N112f	NPT 1 1/2"	18	40	55
M50 x 1,5	APXX/M50m-N200f	NPT 2"	18	40,5	65
M63 x 1,5	APXX/M63m-N200f	NPT 2"	18	40,5	70
M63 x 1,5	APXX/M63m-N212f	NPT 2 1/2"	18	40,5	80
M75 x 1,5	APXX/M75m-N212f	NPT 2 1/2"	18	40,5	80
M75 x 1,5	APXX/M75m-N300f	NPT 3"	18	43,5	95
M90 x 1,5	APXX/M90m-N300f	NPT 3"	21	47	95
M90 x 1,5	APXX/M90m-N400f	NPT 4"	21	47	120
M110 x 1,5	APXX/M110m-N400f	NPT 4"	21	47	120
NPT 1/4"	APXX/N14m-M12f	M12 x 1,5	15	33	18
NPT 1/4"	APXX/N14m-M16f	M16 x 1,5	15	33,5	22
NPT 3/8"	APXX/N38m-M16f	M16 x 1,5	15	33,5	22
NPT 3/8"	APXX/N38m-M20f	M20 x 1,5	15	34	25
NPT 1/2"	APXX/N12m-M20f	M20 x 1,5	15	34	25
NPT 1/2"	APXX/N12m-M25f	M25 x 1,5	15	34	30
NPT 3/4"	APXX/N34m-M25f	M25 x 1,5	15	34	30
NPT 3/4"	APXX/N34m-M32f	M32 x 1,5	15	34	36
NPT 1"	APXX/N100m-M32f	M32 x 1,5	15	34	36
NPT 1"	APXX/N100m-M40f	M40 x 1,5	15	37	45
NPT 1 1/4"	APXX/N114m-M40f	M40 x 1,5	18	40	45
NPT 1 1/4"	APXX/N114m-M50f	M50 x 1,5	18	40	55
NPT 1 1/2"	APXX/N112m-M50f	M50 x 1,5	18	40	55
NPT 1 1/2"	APXX/N112m-M63f	M63 x 1,5	18	40,5	70
NPT 2"	APXX/N200m-M63f	M63 x 1,5	18	40,5	70
NPT 2"	APXX/N200m-M75f	M75 x 1,5	18	40,5	80
NPT 2 1/2"	APXX/N212m-M75f	M75 x 1,5	18	40,5	80
NPT 2 1/2"	APXX/N212m-M90f	M90 x 1,5	18	44	95
NPT 3"	APXX/N300m-M90f	M90 x 1,5	21	47	95
NPT 3"	APXX/N300m-M110f	M110 x 1,5	21	47	115
NPT 4"	APXX/N400m-M110f	M110 x 1,5	21	47	120

ADAPTER



TECHNICAL DETAILS

Type	: AP1-XX / ADAPTER
Protection code	: II 2G Exd/e IIC Gb II 1D Ex ta IIIC Da I M2 Ex d/e I Mb
Certificate	: IEP 15 ATEX 0333U
Material	: Brass, brass with nickel plated, stainless steel
Standards	: EN 60079-0 2009 /60079-1 2007/ 60079-31 2009
O-ring	: NBR / Silicone
Temperature range	: -60 °C +200 °C
Protection class	: IP66-IP68 (EN 60529)
Application area	: ZONE1 , ZONE 2, ZONE 21 , ZONE 22 Gas groups IIA , IIB , IIC

ADAPTER

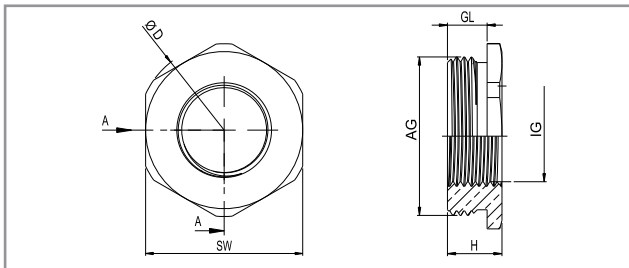
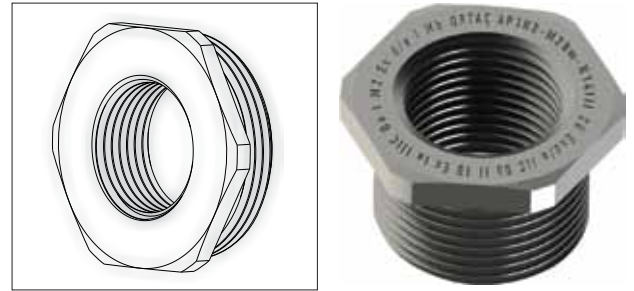

PRODUCT RANGE OVERVIEW

Product Size	Product Code	IG (F)	GL min. mm	H mm	SW mm
M16 x 1,5	AP1XX/M16m-N14f	NPT 1/4"	15	19	22
M20 x 1,5	AP1XX/M20m-N14f	NPT 1/4"	15	19	25
M25 x 1,5	AP1XX/M25m-N12f	NPT 1/2"	15	19	30
M32 x 1,5	AP1XX/M32m-N12f	NPT 1/2"	15	19	36
M32 x 1,5	AP1XX/M32m-N34f	NPT 3/4"	15	19	36
M40 x 1,5	AP1XX/M40m-N34f	NPT 3/4"	18	22	45
M40 x 1,5	AP1XX/M40m-N100f	NPT 1"	18	22	45
M50 x 1,5	AP1XX/M50m-N100f	NPT 1"	18	23	55
M50 x 1,5	AP1XX/M50m-N114f	NPT 1 1/4"	18	23	55
M63 x 1,5	AP1XX/M63m-N114f	NPT 1 1/4"	18	23	70
M63 x 1,5	AP1XX/M63m-N112f	NPT 1 1/2"	18	23	70
M75 x 1,5	AP1XX/M75m-N112f	NPT 1 1/2"	18	24	85
M75 x 1,5	AP1XX/M75m-N200f	NPT 2"	18	24	85
M90 x 1,5	AP1XX/M90m-N200f	NPT 2"	21	29	100
M90 x 1,5	AP1XX/M90m-N212f	NPT 2 1/2"	21	29	100
M110 x 1,5	AP1XX/M110m-N212f	NPT 2 1/2"	21	31	120
M110 x 1,5	AP1XX/M110m-N300f	NPT 3"	21	31	120
NPT 3/8"	AP1XX/N38m-M12f	M12 x 1,5	15	19	22
NPT 1/2"	AP1XX/N12m-M12f	M12 x 1,5	15	19	25
NPT 1/2"	AP1XX/N12m-M16f	M16 x 1,5	15	19	25
NPT 3/4"	AP1XX/N34m-M16f	M16 x 1,5	15	19	30
NPT 3/4"	AP1XX/N34m-M20f	M20 x 1,5	15	19	30
NPT 1"	AP1XX/N100m-M20f	M20 x 1,5	15	19	36
NPT 1"	AP1XX/N100m-M25f	M25 x 1,5	15	19	36
NPT 1 1/4"	AP1XX/Nf114m-M25f	M25 x 1,5	18	18	45
NPT 1 1/4"	AP1XX/N114m-M32f	M32 x 1,5	18	18	45
NPT 1 1/2"	AP1XX/N112m-M32f	M32 x 1,5	18	18	55
NPT 1 1/2"	AP1XX/N112m-M40f	M40 x 1,5	18	18	55
NPT 2"	AP1XX/N200m-M40f	M40 x 1,5	18	18	65
NPT 2"	AP1XX/N200m-M50f	M50 x 1,5	18	18	65
NPT 2 1/2"	AP1XX/N212m-M50	M50 x 1,5	18	18	75
NPT 2 1/2"	AP1XX/N212m-M63f	M63 x 1,5	18	18	75
NPT 3"	AP1XX/N300m-M63f	M63 x 1,5	21	21	95
NPT 3"	AP1XX/N300m-M75f	M75 x 1,5	21	21	95
NPT 4"	AP1XX/N400m-M75f	M75 x 1,5	21	21	120
NPT 4"	AP1XX/N400m-M90f	M90 x 1,5	21	21	120

REDUCER



TECHNICAL DETAILS

Type : RCXX / REDUCER
 Protection code : II 2G Exd/e IIC Gb II 1D Ex ta IIIC Da
 I M2 Ex d/e I Mb
 Certificate : IEP 15 ATEX 0333U
 Material : Brass, brass with nickel plated, stainless steel
 Standards : EN 60079-0 2009 /60079-1 2007/ 60079-31 2009
 O-ring : NBR / Silicone
 Temperature range : -60 °C +200 °C
 Protection class : IP66-IP68 (EN 60529)
 Application area : ZONE1 , ZONE 2, ZONE 21 , ZONE 22
 Gas groups IIA , IIB , IIC

REDUCER

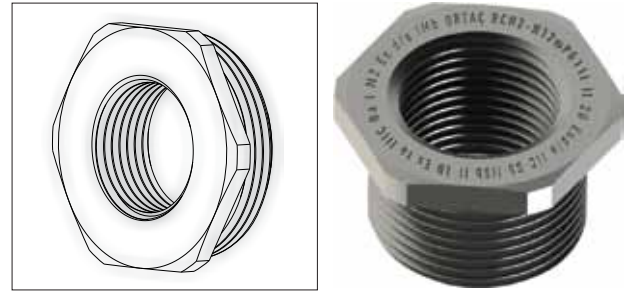
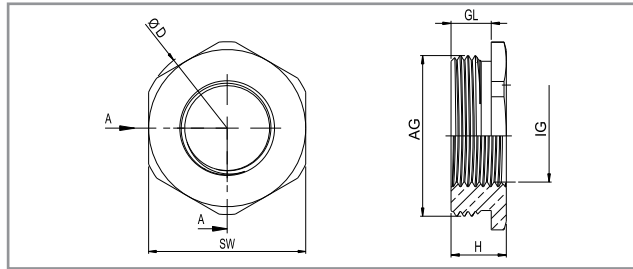

PRODUCT RANGE OVERVIEW

Product Size	Product Code	IG (F)	GL mm	H mm	SW mm
M16 x 1,5	RCXX/M16m-M12f	M12 x 1,5	15	19	22
M20 x 1,5	RCXX/M20m-M12f	M12 x 1,5	15	19	25
M20 x 1,5	RCXX/M20m-M16f	M16 x 1,5	15	19	25
M25 x 1,5	RCXX/M25m-M16f	M16 x 1,5	15	19	30
M25 x 1,5	RCXX/M25m-M20f	M20 x 1,5	15	19	30
M32 x 1,5	RCXX/M32m-M20f	M20 x 1,5	15	19	36
M32 x 1,5	RCXX/M32m-M25f	M25 x 1,5	15	19	36
M40 x 1,5	RCXX/M40m-M25f	M25 x 1,5	18	22	45
M40 x 1,5	RCXX/M40m-M32f	M32 x 1,5	18	22	45
M50 x 1,5	RCXX/M50m-M32f	M32 x 1,5	18	23	55
M50 x 1,5	RCXX/M50m-M40f	M40 x 1,5	18	23	55
M63 x 1,5	RCXX/M63m-M40f	M40 x 1,5	18	23	70
M63 x 1,5	RCXX/M63m-M50f	M50 x 1,5	18	23	70
M75 x 1,5	RCXX/M75m-M50f	M50 x 1,5	18	24	85
M75 x 1,5	RCXX/M75m-M63f	M63 x 1,5	18	24	85
M90 x 1,5	RCXX/M90m-M63f	M63 x 1,5	21	29	100
M90 x 1,5	RCXX/M90m-M75f	M75 x 1,5	21	29	100
M110 x 1,5	RCXX/M110m-M75f	M75 x 1,5	21	31	120
M110 x 1,5	RCXX/M110m-M90f	M90 x 1,5	21	31	120
NPT 3/8"	RCXX/N38m-N14f	NPT 1/4"	15	19	22
NPT 1/2"	RCXX/N12m-N14f	NPT 1/4"	15	19	25
NPT 1/2"	RCXX/N12m-N38f	NPT 3/8"	15	19	25
NPT 3/4"	RCXX/N34m-N38f	NPT 3/8"	15	19	30
NPT 3/4"	RCXX/N34m-N12f	NPT 1/2"	15	19	30
NPT 1"	RCXX/N100m-N12f	NPT 1/2"	15	19	36
NPT 1"	RCXX/N100m-N34f	NPT 3/4"	15	19	36
NPT 1 1/4"	RCXX/N114m-N12f	NPT 1/2"	18	22	45
NPT 1 1/4"	RCXX/N114m-N34f	NPT 3/4"	18	22	45
NPT 1 1/4"	RCXX/N114m-N100f	NPT 1"	18	22	45
NPT 1 1/2"	RCXX/N112m-N12f	NPT 1/2"	18	23	55
NPT 1 1/2"	RCXX/N112m-N34f	NPT 3/4"	18	23	55
NPT 1 1/2"	RCXX/N112m-N100f	NPT 1"	18	23	55
NPT 1 1/2"	RCXX/N112m-N114f	NPT 1 1/4"	18	23	55
NPT 2"	RCXX/N200m-N114f	NPT 1 1/4"	18	23	65
NPT 2"	RCXX/N200m-N112f	NPT 1 1/2"	18	23	65
NPT 2 1/2"	RCXX/N212m-N112f	NPT 1 1/2"	18	24	75
NPT 2 1/2"	RCXX/N212m-N200f	NPT 2"	18	24	75
NPT 3"	RCXX/N300m-N200f	NPT 2"	21	29	95
NPT 3"	RCXX/N300m-N212f	NPT 2 1/2"	21	29	95
NPT 4"	RCXX/N400m-N212f	NPT 2 1/2"	21	31	120
NPT 4"	RCXX/N400m-N300f	NPT 3"	21	31	120

ENLARGER REDUCER



TECHNICAL DETAILS

Type	: RCXX / ENLARGER REDUCER
Protection code	: II 2G Exd/e IIC Gb II 1D Ex ta IIIC Da I M2 Ex d/e I Mb
Certificate	: IEP 15 ATEX 0333U
Material	: Brass, brass with nickel plated, stainless steel
Standards	: EN 60079-0 2009 /60079-1 2007/ 60079-31 2009
O-ring	: NBR / Silicone
Temperature range	: -60 °C +200 °C
Protection class	: IP66-IP68 (EN 60529)
Application area	: ZONE1 , ZONE 2 , ZONE 21 , ZONE 22 Gas groups IIA , IIB , IIC

ENLARGER REDUCER

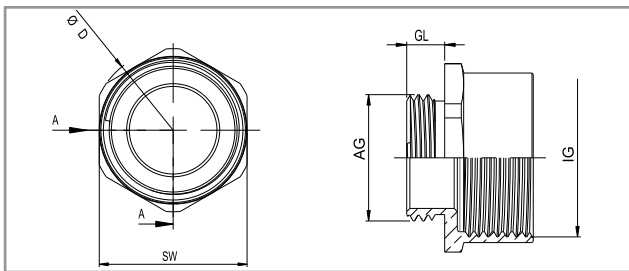
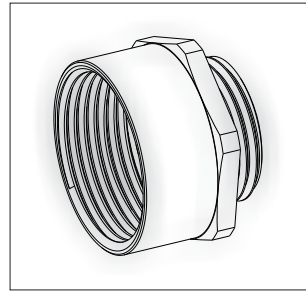

PRODUCT RANGE OVERVIEW

Product Size	Product Code	IG (F)	GL mm	H mm	SW mm
M12 x 1,5	RCXX/M12m-M12f	M12 x 1,5	15	33,5	18
M12 x 1,5	RCXX/M12m-M16f	M16 x 1,5	15	33,5	22
M16 x 1,5	RCXX/M16m-M16f	M16 x 1,5	15	33,5	22
M12 x 1,5	RCXX/M12m-M20f	M20 x 1,5	15	34	25
M16 x 1,5	RCXX/M16m-M20f	M20 x 1,5	15	34	25
M20 x 1,5	RCXX/M20m-M20f	M20 x 1,5	15	34	25
M16 x 1,5	RCXX/M16m-M25f	M25 x 1,5	15	34	30
M20 x 1,5	RCXX/M20m-M25f	M25 x 1,5	15	34	30
M25 x 1,5	RCXX/M25m-M25f	M25 x 1,5	15	34	30
M20 x 1,5	RCXX/M20m-M32f	M32 x 1,5	15	34	36
M25 x 1,5	RCXX/M25m-M32f	M32 x 1,5	15	34	36
M32 x 1,5	RCXX/M32m-M32f	M32 x 1,5	15	34	36
M25 x 1,5	RCXX/M25m-M40f	M40 x 1,5	15	37	45
M32 x 1,5	RCXX/M32m-M40f	M40 x 1,5	15	37	45
M40 x 1,5	RCXX/M40m-M40f	M40 x 1,5	18	40	45
M32 x 1,5	RCXX/M32m-M50f	M50 x 1,5	15	37	55
M40 x 1,5	RCXX/M40m-M50f	M50 x 1,5	18	40	55
M50 x 1,5	RCXX/M50m-M50f	M50 x 1,5	18	40	55
M50 x 1,5	RCXX/M50m-M63f	M63 x 1,5	18	40,5	70
M63 x 1,5	RCXX/M63m-M63f	M63 x 1,5	18	40,5	70
M63 x 1,5	RCXX/M63m-M75f	M75 x 1,5	18	40,5	80
M75 x 1,5	RCXX/M75m-M75f	M75 x 1,5	18	40,5	85
M75 x 1,5	RCXX/M75m-M90f	M90 x 1,5	18	43,5	95
M90 x 1,5	RCXX/M90m-M90f	M90 x 1,5	21	47	95
M90 x 1,5	RCXX/M90m-M110f	M110 x 1,5	21	47	115
M110 x 1,5	RCXX/M110m-M110f	M110 x 1,5	21	47	120
NPT 1/4"	RCXX/N14m-N14f	NPT 1/4"	15	33	18
NPT 1/4"	RCXX/N14m-N38f	NPT 3/8"	15	33,5	20
NPT 3/8"	RCXX/N38m-N38f	NPT 3/8"	15	33,5	20
NPT 3/8"	RCXX/N38m-N12f	NPT 1/2"	15	34	25
NPT 1/2"	RCXX/N12m-N12f	NPT 1/2"	15	34	25
NPT 1/2"	RCXX/N12m-N34f	NPT 3/4"	15	34	30
NPT 3/4"	RCXX/N34m-N34f	NPT 3/4"	15	34	32
NPT 3/4"	RCXX/N34m-N100f	NPT 1"	15	34	36
NPT 1"	RCXX/N100m-N100f	NPT 1"	15	34	36
NPT 1"	RCXX/N100m-N114f	NPT 1 1/4"	15	37	45
NPT 1 1/4"	RCXX/N114m-N114f	NPT 1 1/4"	18	40,5	45
NPT 1 1/4"	RCXX/N114m-N112f	NPT 1 1/2"	18	40,5	55
NPT 1 1/2"	RCXX/N112m-N112f	NPT 1 1/2"	18	40,5	55
NPT 1 1/2"	RCXX/N112m-N200f	NPT 2"	18	40,5	65
NPT 2"	RCXX/N200m-N200f	NPT 2"	18	40,5	65
NPT 2"	RCXX/N200m-N212f	NPT 2 1/2"	18	40,5	80
NPT 2 1/2"	RCXX/N212m-N212f	NPT 2 1/2"	18	40,5	80
NPT 2 1/2"	RCXX/N212m-N300f	NPT 3"	18	43,5	95
NPT 3"	RCXX/N300m-N300f	NPT 3"	21	47	95
NPT 3"	RCXX/N300m-N400f	NPT 4"	21	47	120
NPT 4"	RCXX/N400m-N 400f	NPT 4"	21	47	120

NIPPLE



TECHNICAL DETAILS

Type : NPXX / NIPPLE
 Protection code : II 2G Exd/e IIC Gb II 1D Ex ta IIC Da
 I M2 Ex d/e I Mb
 Certificate : IEP 15 ATEX 0333U
 Material : Brass, brass with nickel plated, stainless steel
 Standards : NBR / Silicone
 Temperature range : -60 °C +200 °C
 Protection class : IP66-IP68 (En 60529)
 Application area : ZONE1, ZONE2, ZONE22
 Gas groups IIA, IIB, IIC

NIPPLE

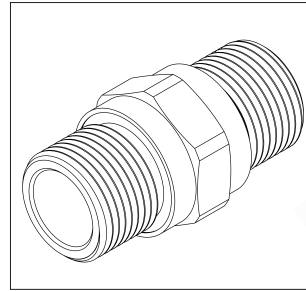
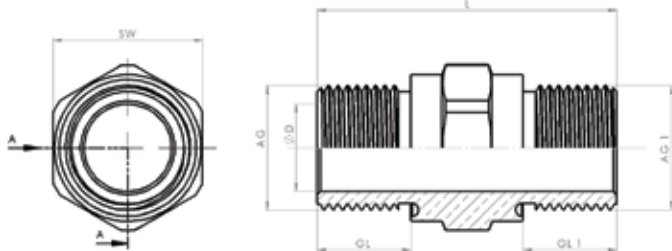

PRODUCT RANGE OVERVIEW

AG	Code	AG 1	D(mm)	L(mm)	GL(mm)	GL 1(mm)	SW
M12 x 1.5	NPXX/M12m-M12m	M12 x 1.5	7	46	15	15	18
M16 x 1.5	NPXX/M16m-M16m	M16 x 1.5	10	48	15	15	20
M20 x 1.5	NPXX/M20m-M20m	M20 x 1.5	14	48	15	15	24
M25 x 1.5	NPXX/M20m-M20m	M25 x 1.5	19	50	15	15	32
M32 x 1.5	NPXX/M32m-M32m	M32 x 1.5	26	50	15	15	36
M40 x 1.5	NPXX/M40m-M40m	M40 x 1.5	34	56	18	18	45
M50 x 1.5	NPXX/M50m-M50m	M50 x 1.5	44	58	18	18	55
M63 x 1.5	NPXX/M63m-M63m	M63 x 1.5	57	58	18	18	70
M75 x 1.5	NPXX/M75m-M75m	M75 x 1.5	69	62	18	18	85
M90 x 1.5	NPXX/M90m-M90m	M90 x 1.5	84	68	21	21	100
M110 x 1.5	NPXX/M110m-M110m	M110 x 1.5	100	69	21	21	120
NPT 1/4"	NPXX/N14m-M12m	M12 x 1.5	7	46	15	15	18
NPT 3/8"	NPXX/N38m-M16m	M16 x 1.5	10	48	15	15	20
NPT 1/2"	NPXX/N12m-M20m	M20 x 1.5	14	48	15	15	24
NPT 3/4"	NPXX/N34m-M25m	M25 x 1.5	19	50	15	15	32
NPT 1"	NPXX/N100m-M32m	M32 x 1.5	26	50	15	15	36
NPT 1 1/4"	NPXX/N114m-M40m	M40 x 1.5	34	56	18	18	45
NPT 1 1/2"	NPXX/N112m-M50m	M50 x 1.5	44	58	18	18	55
NPT 2"	NPXX/N200m-M63m	M63 x 1.5	57	58	18	18	70
NPT 2 1/2"	NPXX/N212m-M75m	M75 x 1.5	69	62	18	18	85
NPT 3"	NPXX/N300m-M90m	M90 x 1.5	84	68	21	21	100
NPT 4"	NPXX/N400m-M110m	M110 x 1.5	100	69	21	21	120
NPT 1/4"	NPXX/N14m-N14m	NPT 1/4"	8	46	15	15	18
NPT 1/4"	NPXX/N14m-N38m	NPT 3/8"	8	48	15	15	20
NPT 3/8"	NPXX/N38m-N38m	NPT 3/8"	12	48	15	15	20
NPT 3/8"	NPXX/N38m-N12m	NPT 1/2"	12	48	15	15	24
NPT 1/2"	NPXX/N12m-N12m	NPT 1/2"	15.5	48	15	15	24
NPT 1/2"	NPXX/N12m-N34m	NPT 3/4"	15.5	50	15	15	32
NPT 3/4"	NPXX/N34m-N34m	NPT 3/4"	19	50	15	15	32
NPT 3/4"	NPXX/N34m-N100m	NPT 1"	19	50	15	15	36
NPT 1"	NPXX/N100m-N100m	NPT 1"	25	50	15	15	36
NPT 1"	NPXX/N100m-N114m	NPT 1 1/4"	25	53	15	15	45
NPT 1 1/4"	NPXX/N114m-N114m	NPT 1 1/4"	33	56	18	18	45
NPT 1 1/2"	NPXX/N112m-N112m	NPT 1 1/2"	40	58	18	18	55
NPT 2"	NPXX/N200m-N200m	NPT 2"	52	58	18	18	65
NPT 2 1/2"	NPXX/N212m-N212m	NPT 2 1/2"	62	62	18	18	80
NPT 3"	NPXX/N300m-N300m	NPT 3"	75	68	21	21	95
NPT 4"	NPXX/N400m-N400m	NPT 4"	100	69	21	21	120

COUPLING



TECHNICAL DETAILS

Type : CPXX / COUPLING
 Protection code : II 2G Exd/e IIC Gb II 1D Ex ta IIIC Da
 I M2 Ex d/e I Mb
 Certificate : IEP 15 ATEX 0333U
 Material : Brass, brass with nickel plated, stainless steel
 Standards : NBR / Silicone
 Temperature range : -60 °C +200 °C
 Protection class : IP66-IP68 (En 60529)
 Application area : ZONE1, ZONE2, ZONE21, ZONE22
 Gas groups IIA, IIB, IIC

COUPLING

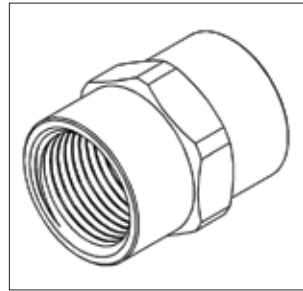
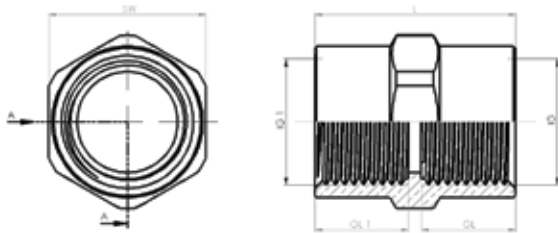

PRODUCT RANGE OVERVIEW

IG	Code	IG 1	D (mm)	L (mm)	GL	GL 1	SW
M12 x 1.5	CPXX/M12f-M12f	M12 x 1.5	9.5	32	15	15	18
M16 x 1.5	CPXX/M16f-M12f	M12 x 1.5	9.5	33	15	15	20
M16 x 1.5	CPXX/M16f-M16f	M16 x 1.5	13	33	15	15	20
M20 x 1.5	CPXX/M20f-M16f	M16 x 1.5	13.5	32	15	15	25
M20 x 1.5	CPXX/M20f-M20f	M20 x 1.5	16	32	15	15	25
M25 x 1.5	CPXX/M25f-M20f	M20 x 1.5	17	33	15	15	32
M25 x 1.5	CPXX/M25f-M25f	M25 x 1.5	22	33	15	15	32
M32 x 1.5	CPXX/M32f-M25f	M25 x 1.5	22	34	15	15	36
M32 x 1.5	CPXX/M32f-M32f	M32 x 1.5	29	32	15	15	36
M40 x 1.5	CPXX/M40f-M32f	M32 x 1.5	29	37	18	18	45
M40 x 1.5	CPXX/M40f-M40f	M40 x 1.5	37	38	18	18	45
M50 x 1.5	CPXX/M50f-M40f	M40 x 1.5	37.5	40	18	18	55
M50 x 1.5	CPXX/M50f-M50f	M50 x 1.5	47	38	18	18	55
M63 x 1.5	CPXX/M63f-M50f	M50 x 1.5	47	41	18	18	68
M63 x 1.5	CPXX/M63f-M63f	M63 x 1.5	60	38	18	18	68
M75 x 1.5	CPXX/M75f-M63f	M63 x 1.5	60	41	18	18	80
M75 x 1.5	CPXX/M75f-M75f	M75 x 1.5	72	38	18	18	80
M90 x 1.5	CPXX/M90f-M75f	M75 x 1.5	72	45	21	21	95
M90 x 1.5	CPXX/M90f-M90f	M90 x 1.5	87	44	21	21	95
M110 x 1.5	CPXX/M110f-M110f	M110 x 1.5	107	44	21	21	120

COUPLING



TECHNICAL DETAILS

Type : CPXX / COUPLING
 Protection code : II 2G Exd/e IIC Gb II 1D Ex ta IIIC Da
 I M2 Ex d/e I Mb
 Certificate : IEP 15 ATEX 0333U
 Material : Brass, brass with nickel plated, stainless steel
 Standards : NBR / Silicone
 Temperature range : -60 °C +200 °C
 Protection class : IP66-IP68 (En 60529)
 Application area : ZONE1, ZONE2, ZONE21, ZONE22
 Gas groups IIA, IIB, IIC

COUPLING

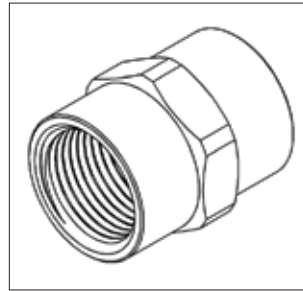
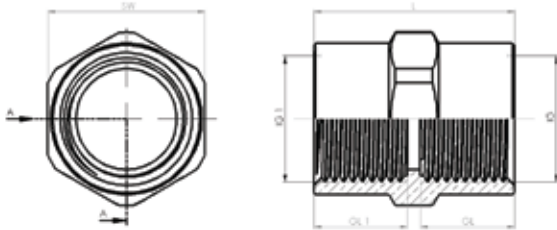

PRODUCT RANGE OVERVIEW

IG	Code	IG 1	D(mm)	L(mm)	GL	GL 1	SW
NPT 1/4"	CPXX/N14f-M12f	M12 x 1.5	9.5	32	15	15	18
NPT 3/8"	CPXX/N38f-M12f	M12 x 1.5	9.5	33	15	15	20
NPT 3/8"	CPXX/N38f-M16f	M16 x 1.5	12.5	32	15	15	20
NPT 1/2"	CPXX/N12f-M16f	M16 x 1.5	14	32	15	15	25
NPT 1/2"	CPXX/N12f-M20f	M20 x 1.5	16	32	15	15	25
NPT 3/4"	CPXX/N34f-M20f	M20 x 1.5	17	33	15	15	32
NPT 3/4"	CPXX/N34f-M25f	M25 x 1.5	22	32	15	15	32
NPT 1"	CPXX/N100f-M25f	M25 x 1.5	22.5	33	15	15	36
NPT 1"	CPXX/N100f-M32f	M32 x 1.5	28	32	15	15	36
NPT 1 1/4"	CPXX/N114f-M32f	M32 x 1.5	29	37	15	15	45
NPT 1 1/4"	CPXX/N114f-M40f	M40 x 1.5	35.5	38	15	15	45
NPT 1 1/2"	CPXX/N112f-M40f	M40 x 1.5	38	39	18	15	55
NPT 1 1/2"	CPXX/N112f-M50f	M50 x 1.5	42	39	18	18	55
NPT 2"	CPXX/N200f-M50f	M50 x 1.5	48	39	18	18	65
NPT 2"	CPXX/N200f-M63f	M63 x 1.5	54	39	18	18	68
NPT 2 1/2"	CPXX/N212f-M63f	M63 x 1.5	60	40	18	18	80
NPT 2 1/2"	CPXX/N212f-M75f	M75 x 1.5	64	40	18	18	80
NPT 3"	CPXX/N300f-M75f	M75 x 1.5	72	44	21	18	95
NPT 3"	CPXX/N300f-M90f	M90 x 1.5	79.5	46	21	21	95
NPT 4"	CPXX/N400f-M90f	M90 x 1.5	87	49	21	21	120
NPT 4"	CPXX/N400f-M110f	M110 x 1.5	105	45	21	21	120
NPT 1/4"	CPXX/N14f-N14f	NPT 1/4"	9.5	32	15	15	18
NPT 3/8"	CPXX/N38f-N14f	NPT 1/4"	9.5	33	15	15	20
NPT 3/8"	CPXX/N38f-N38f	NPT 3/8"	12.5	32	15	15	20
NPT 1/2"	CPXX/N12f-N38f	NPT 3/8"	13	33	15	15	25
NPT 1/2"	CPXX/N12f-N12f	NPT 1/2"	16	32	15	15	25
NPT 3/4"	CPXX/N34f-N12f	NPT 1/2"	16	33	15	15	32
NPT 3/4"	CPXX/N34f-N34f	NPT 3/4"	21	32	15	15	32
NPT 1"	CPXX/N100f-N34f	NPT 3/4"	21	33	15	15	36
NPT 1"	CPXX/N100f-N100f	NPT 1"	27	32	15	15	36
NPT 1 1/4"	CPXX/N114f-N100f	NPT 1"	35.5	37	18	15	45
NPT 1 1/4"	CPXX/N114f-N114f	NPT 1 1/4"	36	38	18	18	45
NPT 1 1/2"	CPXX/N112f-N114f	NPT 1 1/4"	41.5	39	18	18	55
NPT 1 1/2"	CPXX/N112f-N112f	NPT 1 1/2"	41.5	38	18	18	55
NPT 2"	CPXX/N2f-N112f	NPT 1 1/2"	41.5	42	18	18	65
NPT 2"	CPXX/N2f-N2f	NPT 2"	53.5	38	18	18	65
NPT 2 1/2"	CPXX/N212f-N2f	NPT 2"	53.5	41	18	18	80
NPT 2 1/2"	CPXX/N212f-N212f	NPT 2 1/2"	64	40	18	18	80
NPT 3"	CPXX/N300f-N212f	NPT 2 1/2"	64	46	21	18	95
NPT 3"	CPXX/N300f-N300f	NPT 3"	80	44	21	21	95
NPT 4"	CPXX/N400f-N300f	NPT 3"	81	45	21	21	120
NPT 4"	CPXX/N400f-N400f	NPT 4"	105	45	21	21	120

SHROUDS



SHROUD

TECHNICAL DETAILS

Type : PS / SHROUDS
 Material : TPV / PVC / LSF
 Temperature range: -20 °C +80 °C
 Protection class : IP66-IP68 (EN 60529)

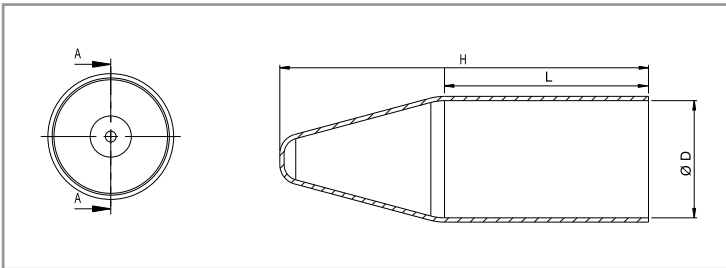
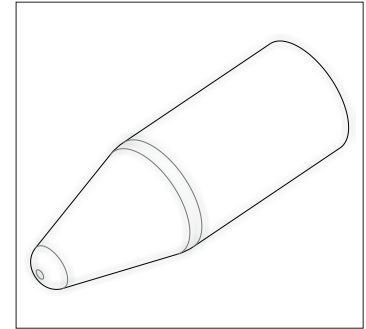

PRODUCT RANGE OVERVIEW

Product Size	Product Code	Ø D mm	H mm	L mm
M16	PS-16	25	100	60
M20	PS-20	32	110	65
M25	PS-25	41	130	70
M32	PS-32	49	145	77
M40	PS-40	60	170	85
M50s	PS-50s	65	155	86
M50	PS-50	75	175	92
M63s	PS-63s	81	180	92
M63	PS-63	86	180	92
M75s	PS-75s	100	220	115
M75	PS-75	110	220	115
M90	PS-90	-	-	-

EARTHING PARTS



EARTH TAG

TECHNICAL DETAILS

Type : RTE / EARTH TAG
 Material : MS 64 with Nickel Plated / Stainless Steel
 Temperature range : -40 °C + 100 °C

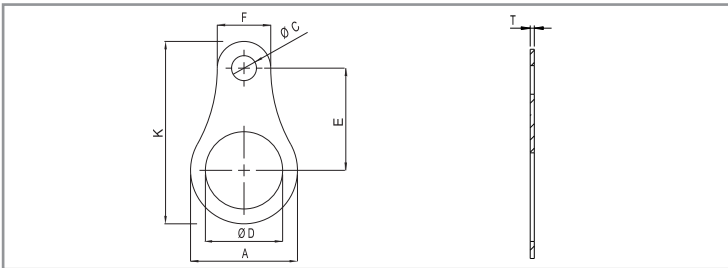
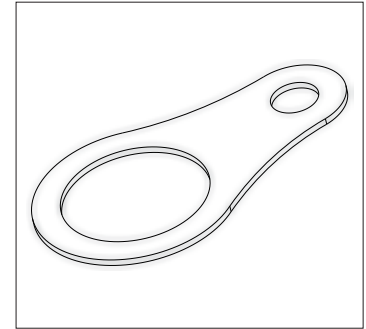

PRODUCT RANGE OVERVIEW

Product Size	Product Code	A	ØD	ØC	F	K	E	T
M16	RTE-16	25,4	16,5	6,5	12,5	49	30	1
M20	RTE-20	27	20,5	6,5	10,2	51,6	33	1
M25	RTE-25	35	25,5	6,5	13,5	60	35,5	1
M32	RTE-32	45	32,5	10,5	22,5	76,75	43	1
M40	RTE-40	53,5	40,5	10,5	23,6	83,5	45	1
M50	RTE-50	65	50,5	10,5	29,5	105,25	58	1
M63	RTE-63	82	63,5	10,5	29,5	122,75	67	1
M75	RTE-75	96	75,5	6,5	24	-	73	1,5
M90	RTE-90	114	90,5	6,5	37	-	86	1,5
M100	RTE-100	-	-	-	-	-	-	-



EXPROOF FLEXIBLE CONDUIT GLANDS



FLEXIBLE SPIRAL CONDUIT GLANDS
LIQUID TIGHT
WITH CABLE HOLDER

TECHNICAL DETAILS

Certificate : IEP 15 ATEX 0355 U
 Protection code : II 2G Exd/e IIC Gb II 1D Ex ta IIIC Da I M2 Exd/e I Mb
 Standards : EN 60079-0:2009, 60079-1:2007, 60079-31:2009
 Protection class : IP67
 Temperature range : -20 °C +80 °C

Material

Cup nut : Brass with nickel plated
 Clamping insert : PA6 V0
 Sealing ring : TPV
 Ring : PA6 V0
 Ferrule : Aluminium / brass
 Gland body : Brass with nickel plated
 O-ring : NBR / silicone
 Connection thread : Metric EN (60423)/ASME B 10.20.1 / DIN 259

Properties

Easy to assemble
 Fixed or swivel body version
 Apply with either LGT or CTS, CTPS conduits

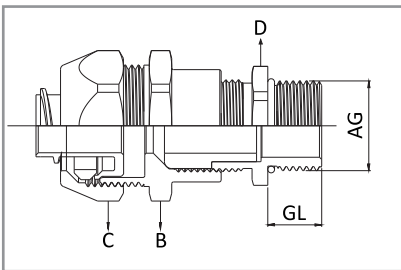
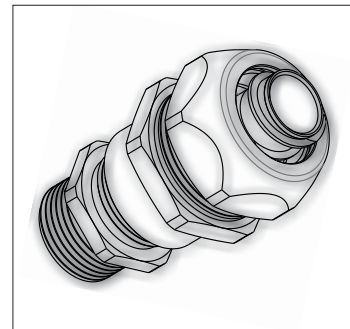

PG FIXED/SWIVEL BODY

Code	AG Thread	Spiral Measure	GL min. mm	B mm.	C mm.	D mm.	Cables mm.
MLSRP 00	PG 7	10-1/4"	15	20	22	14	3-6,5
MLSRP 1A	PG 9	10-1/4"	15	20	22	17	4-8
MLSRP 01	PG 11	13-3/8"	15	24	26	20	5-10
MLSRP 2A	PG 13,5	16-1/2"	15	27	29	22	6-12
MLSRP 02	PG 16	16-1/2"	15	27	29	24	10-14
MLSRP 03	PG 21	21-3/4"	15	33	35	30	13-18
MLSRP 04	PG 29	26-1"	15	43	45	40	18-25
MLSRP 05	PG 36	35-1 1/4"	15	52	54	50	22-32
MLSRP 06	PG 42	40-1 1/2"	15	60	63	57	30-38
MLSRP 07	PG 48	51-2"	15	74	77	64	34-44

IP 67

PRODUCT RANGE OVERVIEW

METRIC FIXED/SWIVEL BODY

Code	AG Thread	Spiral Measure	GL min. mm	B mm.	C mm.	D mm.	Cables mm.
MLSRM 00	M 12 x 1,5	10-1/4"	15	20	22	14	3-6,5
MLSRM 1A	M 16 x 1,5	10-1/4"	15	20	22	18	4-8
MLSRM 01	M 16 x 1,5	13-3/8"	15	24	26	18	4-8
MLSRM 02	M 20 x 1,5	16-1/2"	15	27	29	22	6-12
MLSRM 03	M 25 x 1,5	21-3/4"	15	33	35	27	10-14
MLSRM 04	M 32 x 1,5	26-1"	15	43	45	34	13-18
MLSRM 05	M 40 x 1,5	35-1 1/4"	15	52	54	43	18-25
MLSRM 06	M 50 x 1,5	40-1 1/2"	15	60	63	55	22-32
MLSRM 07	M 63 x 1,5	51-2"	15	74	77	68	34-44